

# 30AMP PWM BLUETOOTH® SOLAR CONTROLLER

## User Manual

GP-PWM-30-UL (BLUETOOTH®-ENABLED - LITHIUM COMPATIBLE)



© 2022 Go Power!

Worldwide Technical Support and Product Information [gpelectric.com](http://gpelectric.com)

Go Power! | Dometic

201-710 Redbrick Street Victoria, BC, V8T 5J3

Tel: 1.866.247.6527

Manual\_GP-PWM-30-UL





# CONTENTS

1. INSTALLATION OVERVIEW.....	4
1.1 INTRODUCTION .....	4
1.2 SYSTEM VOLTAGE AND CURRENT.....	4
1.3 BATTERY TYPE.....	4
1.4 LOW VOLTAGE DISCONNECT FUNCTION (USB PORT) .....	4
1.5 BLUETOOTH® WIRELESS TECHNOLOGY .....	4
1.6 REGULATORY INFORMATION .....	4
1.7 SPECIFICATIONS.....	5
2. WARNINGS .....	5
3. TOOLS AND MATERIALS NEEDED .....	6
4. CHOOSING A LOCATION .....	7
5. CHOOSING A BATTERY .....	7
6. INSTALLATION INSTRUCTIONS .....	7
7. WIRING DIAGRAM .....	8
7.1 CHARGING ONLY ONE BATTERY .....	9
7.2 CHARGING TWO BATTERIES.....	9
8. OPERATING INSTRUCTIONS .....	10
8.1 POWER UP.....	10
8.2 SETTING THE BATTERY CHARGING PROFILE .....	10
8.3 BATTERY CHARGING PROFILE CHART .....	11
8.4 MAXIMUM POWER BOOST TECHNOLOGY™ .....	12
8.5 VIEWING THE CONTROLLER DISPLAY INFORMATION.....	13
8.6 RESETTING THE AMPERE HOURS CHARGED .....	15
8.7 ERRORS .....	16
9. DISPLAY SYMBOLS.....	17

- 10. INVERTER CONTROL (ON/OFF)..... 19
- 11. USB CHARGING..... 21
- 12. BLUETOOTH® WIRELESS TECHNOLOGY..... 21
  - 12.1 PAIRING..... 21
  - 12.2 APP SETTINGS..... 22
  - 12.3 GENERAL INFO ..... 22
- 13. FREQUENTLY ASKED QUESTIONS (FAQS) ..... 22
- 14. TROUBLESHOOTING PROBLEMS..... 23
  - 11.1 PROBLEMS WITH THE DISPLAY..... 24
  - 11.2 PROBLEMS WITH VOLTAGE ..... 24
  - 11.3 PROBLEMS WITH CURRENT..... 24
- 15. LIMITED WARRANTY ..... 25
  - 15.1 REPAIR AND RETURN INFORMATION..... 25
- 16. INSTALLATION TEMPLATE ..... 26



# 1. INSTALLATION OVERVIEW

## 1.1 INTRODUCTION

A Solar Controller (or Charge Controller / Regulator) is an essential component of your photovoltaic solar system. The Controller maintains the life of the battery by protecting it from overcharging. When your battery has reached a 100% state of charge, the Controller prevents overcharging by limiting the current flowing into the batteries from your solar array.

The GP-PWM-30-UL uses Pulse Width Modulation (PWM) technology and a unique four stage charging system that includes an optional equalize setting to charge and protect your battery bank. The GP-PWM-30-UL features an LCD digital display that shows the charge current of the solar array, system battery voltage and battery state of charge. The GP-PWM-30-UL also features Maximum Power Boost Technology™ for manual bulk and absorption charge at any stage of the charge cycle.

## 1.2 SYSTEM VOLTAGE AND CURRENT

GP-PWM-30-UL is intended for use at 12 VDC system voltage and is rated for a maximum continuous DC input current of 37.5A and input voltage of 35VDC.

Per National Electrical Code (NEC) article 690.7 and 690.8, PV module nameplate ratings must be multiplied by required values (typically 1.25 for both voltage and current) to obtain the maximum voltage and continuous current available from the module.

Applying NEC factors, the maximum allowable nameplate PV Panel rated  $I_{sc}$  is 30A ( $30A \times 1.25 = 37.5A$ ), and the maximum voltage,  $V_{oc}$  is 28VDC ( $28VDC \times 1.25 = 35VDC$ ).

The voltage and current ratings of all equipment connected to PV panels must be capable of accepting the voltage and current levels available from PV panels installed in the field.

## 1.3 BATTERY TYPE

The GP-PWM-30-UL is suitable for use with lead acid batteries (vented, GEL, or AGM type) as well as some lithium iron phosphate (LiFePO4) batteries that are supplied with a Battery Management System (BMS).

## 1.4 LOW VOLTAGE DISCONNECT FUNCTION (USB PORT, INVERTER REMOTE SIGNAL)

To protect the battery against over-discharge this function automatically switches off the USB output port when Battery 1 voltage is lower than 11.0 VDC. If a compatible inverter is connected and set to remote mode, the controller will also switch off the inverter. This will occur with a delay of 2 to 3 minutes.

As soon as Battery 1 reaches a voltage of 12.2 VDC (for LFP) or 12.8 VDC (for SEALED, AGM, or FLOODED) the USB output port is switched on again. If a compatible inverter is connected and in remote mode, it will also be switched on again.

## 1.5 BLUETOOTH® WIRELESS TECHNOLOGY

The latest versions of GP-PWM-30-UL have integrated Bluetooth® Low Energy wireless technology ready to be paired to your mobile device using the Go Power! Connect app available for download from the App Store and Play Store

## 1.6 REGULATORY INFORMATION



RoHS



PHOTOVOLTAIC CHARGE  
CONTROLLER FOR USE IN  
LAND VEHICLES  
NO. E500409

## 1.7 SPECIFICATIONS

DESCRIPTION	VALUE	
Nominal System Voltage	12 VDC	
Charging Output Voltage Range Battery 1	9 – 14.9 VDC	
Charging Output Voltage Range Battery 2	9 – 14.9 VDC	
Maximum Charge Current Battery 1	37.5 A	
Maximum Charge Current Battery 2	37.5 A	
Maximum Solar DC Input Voltage	35 VDC	
Maximum Series Fuse or Circuit Breaker Solar/Battery	15 A	
Range of DC Input Voltage	9.0 – 35.0 VDC	
Maximum DC Input Operating Current	37.5 A	
Maximum DC Short Circuit Current	37.5 A	
Max. Series Fuse or Circuit Breaker Solar/Battery 1/Battery 2	50 A	
Operating Consumption (Display backlight on)	15mA	
Operating Consumption (Display backlight off)	6 mA	
Battery Types Supported	Vented and Sealed (GEL, AGM etc.) Lead Acid Lithium Iron Phosphate (LFP or LiFePO4)	
Bulk/Absorption Voltage (Sealed/Gel, AGM/LFP, Flooded)	14.1/14.4/14.4VDC (25°C / 77°F), 30min / Day or 2hr if battery voltage < 12.3 VDC	
Absorption Voltage (LiFePO4)	14.4V - 30min / Day	
Float Voltage (Sealed/Gel, AGM, Flooded)	13.7V (25°C / 77°F), 14.0V(Lithium)	
Equalization Voltage (Sealed only)	14.9V (25°C / 77°F), 2h / 28 Day or if battery voltage < 12.1 VDC	
Temperature Compensation (Sealed/Gel, AGM, Flooded)	- 24mV/°C / -13V/°F	
USB charger	5V, 1500mA	
Low Voltage Disconnect (USB)	11.0 VDC Reconnects once battery reaches: 12.8V for Sealed/Gel, AGM, Flooded 12.2V for LiFePO4	
Operating Temperature	- 40 to 85°C / - 40 to 185°F	
Display Operating Temperature	- 10 to 55°C / 14 to 131°F	
Charge Current De-Rating (Based on internal temperature of the controller)	Internal Temp.	Max Charge Output Current
	<80°C/176°F	37.5A
	80°C/176°F	22.5A
	81°C/177.8°F	15A
	82°C/179.6°F	7.5A
>82°C/179.6°F	0A	

Dimensions (H x W x D):  
108 x 190 x 35 mm  
4.25 x 7.48 x 1.38 in

Weight: 300g / 10.6 oz

Maximum Wire Gauge:  
#4 AWG

Warranty: 5 years

- PWM Charging
- 3 Battery Charging profiles
- 4 Stage Charging
- Monthly Equalize option
- Displays Charging Current, Battery Voltage and Battery State of Charge
- Reverse Polarity protected
- Temperature Compensated
- RoHS Compliant, environmentally safe
- Accepts up to 600 watts of solar at 12 volts
- Maximum Power Boost Technology

Humidity	99% N.C
Protection	Battery Reverse Polarity, Solar Array Reverse Polarity, Over Temperature, PV Short Circuit, Over Current
Communication	Bluetooth® (Use with Go Power! Connect app)

## 2. WARNINGS



### Disconnect all power sources

Electricity can be very dangerous. Installation should be performed only by a licensed electrician or qualified personnel.



### Battery and wiring safety

Observe all safety precautions of the battery manufacturer when handling or working around batteries. When charging, batteries produce hydrogen gas, which is highly explosive.



### Wiring connections

Ensure all connections are tight and secure. Loose connections may generate sparks and heat. Be sure to check connections one week after installation to ensure they are still tight.



### Work safely

Wear protective eye wear and appropriate clothing during installation. Use extreme caution when working with electricity and when handling and working around batteries. Use properly insulated tools only.



### Observe correct polarity at all times

Reverse polarity of the Battery 1 terminals will cause the controller to give a warning tone. Reverse connection of Battery 2 terminals will not cause an alarm. However, the controller will not charge or display information for Battery 2 on the LCD. The controller will not function unless Battery 1 terminals are connected to a battery with proper polarity. Failure to correct this fault could damage the controller.



### Do not exceed the GP-PWM-30-UL max current ratings

The maximum current of the solar system is the sum of parallel-connected PV module-rated short circuit currents ( $I_{sc}$ ) multiplied by 1.25. The resulting system current is not to exceed 37.5A. If your solar system exceeds this value, contact your dealer for a suitable controller alternative.

### Do not exceed the GP-PWM-30-UL max voltage ratings

The maximum voltage of the array is the sum of the PV module-rated open-circuit voltage of the series connected modules multiplied by 1.25 (or by a value from NEC 690.7 provided in Table 690.7 A). The resulting voltage is not to exceed 35V. If your solar system exceeds this value, contact your dealer for a suitable controller alternative.

## 3. TOOL AND MATERIALS NEEDED



- Flathead Screwdriver (for wire terminals)
- Philips Screwdriver (for mounting screws)
- Wire Cutter /Stripper

### Note

If the GP-PWM-30-UL Controller was purchased with a Go Power! RV Solar Power Kit, then UV resistant wire is included. For instructions regarding the Go Power! RV Solar Power Kit installation, please refer to the Installation Guide provided with the Kit.

## 4. CHOOSING A LOCATION

The GP-PWM-30-UL is designed to be mounted flush against a wall, out of the way but easily visible.

The GP-PWM-30-UL should be:

- Mounted as close to battery bank 1 as possible
- Mounted on a vertical surface to optimize cooling of the unit
- Indoors, protected from the weather

In an RV, the most common controller location is above the refrigerator. The wire from the solar array most commonly enters the RV through the fridge vent on the roof or by using the Go Power! Cable Entry Plate (sold separately) that allows installers to run wires through any part of the roof. PV connections should connect directly to the controller. Positive and negative battery connections must connect directly from the controller to the batteries. Use of a positive or negative distribution bus is allowed between the controller and battery as long as it is properly sized, electrically safe and an adequate wire size is maintained.

## 5. CHOOSING A BATTERY

The GP-PWM-30-UL is suitable for use with lead acid batteries (vented, GEL, or AGM type) as well as some lithium iron phosphate (LiFePO4) batteries that are supplied with a Battery Management System (BMS). If using lithium ion, it must be lithium iron phosphate (LiFePO4) chemistry with a BMS. No other chemistries are compatible.

Lithium batteries typically have maximum allowed charge currents. These maximums typically decrease in cold temperatures. GP-PWM-30-UL does not limit current for these restrictions, and system design of the solar array must account for this.

Be sure to follow all battery manufacturer safety instructions.

## 6. INSTALLATION INSTRUCTIONS

1. **Prepare for mounting.** Use the template provided on page 17 to mark the four mounting holes and the cutting line for flush mounting your controller.
2. **Complete the installation of the solar modules.** If this GP-PWM-30-UL was purchased as part of a Go Power! Solar Power Kit follow the Installation Guide provided. Otherwise, follow manufacturer's instructions for solar module mounting and wiring.
3. **Select wire type and gauge.** If this GP-PWM-30-UL was purchased as part of a Go Power! Solar Power Kit, appropriate wire type, gauge and length is provided. Please continue to Section 8, "Operating Instructions." If the GP-PWM-30-UL was purchased separately, follow the instructions included here.

### Wire Strip Gauge

You will find a strip gauge diagram on the back of the GP-PWM-30-UL, which helps you to strip your wires to the correct length. Insert wire into the concave slot of the strip gauge until it meets the back of the Strip Gauge slot. Mark the length of wire from the back of the Strip Gauge slot to the edge of the controller with a pen or your finger and strip all wires to be connected to the controller to this length.

### Suggested Minimum Wire Gauge

(Cable length 25 ft. max. from solar array to battery bank).

Wire Type	Wire size min (AWG)	Wire size Max (AWG)
Copper Only, 90°C	AWG 10	AWG 4

**IMPORTANT:** Identify the polarity (positive and negative) on the cable used for the battery and solar module. Use colored wires or mark the wire ends with tags. Although the GP-PWM-30-UL is protected, a reverse polarity contact may damage the unit.

**Wiring the GP-PWM-30-UL.** Wire the GP-PWM-30-UL according to the wiring schematic in Section 7. Run wires from the solar array and the batteries to the location of the GP-PWM-30-UL. Keep the solar array covered with an opaque material until all wiring is completed.

**IMPORTANT:** All wiring must be in accordance to National Electrical Code, ANSI/NFPA 70. Always use appropriate circuit protection on any conductor attached to a battery.

- Connect the battery wiring to the controller first and then connect the battery wiring to the battery.
- Torque all terminal screws per the following:

Stranded Copper 90°C Wire	
Wire Size AWG	Rated Torque (in-lbs)
10	20
8	25
6	35
4	35

With battery power attached, the controller should power up and display information. Connect the solar wiring to the controller and remove the opaque material from the solar array. The negative solar array and battery wiring must be connected directly to the controller for proper operation. Do not connect the negative solar array or negative battery controller wiring to the chassis of the vehicle.

- Mounting the GP-PWM-30-UL.** Mount the GP-PWM-30-UL to the wall using the included four mounting screws.

**IMPORTANT:** You must set the battery type on the GP-PWM-30-UL before you begin to use the controller (follow steps in Section 7). The default battery setting is for AGM/LiFePO4 batteries.

Congratulations, your GP-PWM-30-UL should now be operational. If the battery power is low and the solar array is producing power, your battery should begin to charge.

- Re-torque:** After 30 days of operation, re-torque all terminal screws to ensure the wires are properly secured to the controller.



**WARNING:** This unit is not provided with a GFDI device. This charge controller must be used with an external GFDI device as required by Article 690 of the National Electric Code for the installation location.

## 7. WIRING DIAGRAMS

The GP-PWM-30-UL Maximum 37.5A rating is based on a 30-amp total maximum short circuit current rating (Isc) from the solar modules nameplate ratings. The National Electric Code specifies the PV equipment/system rating to be 125% of the maximum Isc from the PV module ratings (1.25 times 30 = 37.5A). E.G. Three modules in parallel with an Isc of 7 amps each equal a total Isc input of 21 amps. When selecting PV modules for use with the GP-PWM-30-UL do not exceed a total nameplate Isc current of 30A. Solar modules list the Isc amps on their nameplate label.



## 7.1 CHARGING ONLY ONE BATTERY

Use the following wiring diagram if you are using the GP-PWM-30-UL to charge only one battery. Connect your battery to the battery 1 terminals on the solar controller.

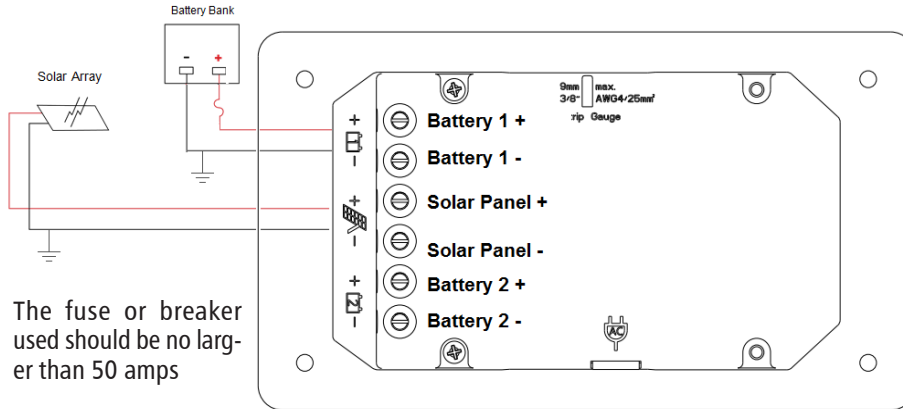

**Note** The controller will not work unless there is a battery connected to the Battery 1 terminals.



**WARNING:** When the photovoltaic (solar) array is exposed to light, it supplies a dc voltage to this equipment.

## 7.2 CHARGING TWO BATTERIES

Use the following wiring diagram if you are using the GP-PWM-30-UL to charge two separate battery banks. Connect battery bank 1 to the battery 1 terminals and battery bank 2 to the battery 2 terminals on the back of the solar controller.

**IMPORTANT:** Ensure your primary/permanent battery (house bank) is connected to the battery 1 terminals. Connect your secondary battery to battery 2 terminals only. Your permanent battery (battery 1) will receive the full current first. Once battery 1 is fully charged, current will be available to charge battery 2.

**Note** The controller will not work unless there is a battery connected to the battery 1 terminals.

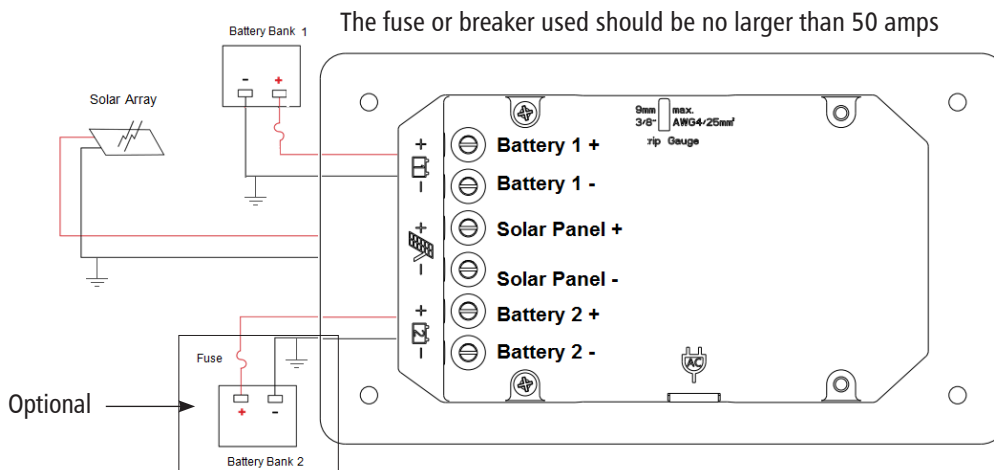



**WARNING:** When the photovoltaic (solar) array is exposed to light, it supplies a dc voltage to this equipment.

## 8. OPERATING INSTRUCTIONS

### 8.1 POWER UP

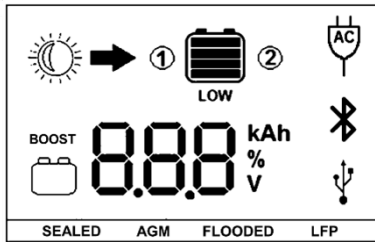

When the GP-PWM-30-UL is connected to the battery, the controller will go into Power Up mode.

**Icons Displayed:** All segments of the numerical display; Backlight blinks.

Depending on the battery voltage when the GP-PWM-30-UL Power Up occurs, the controller may do a Boost Charge or quickly go into Float Charge. The Charging Profile selected will commence the following day after a Power Up (refer to the Charging Profile Chart on page 17-18 for more details).

### 8.2 SETTING THE BATTERY CHARGING PROFILE

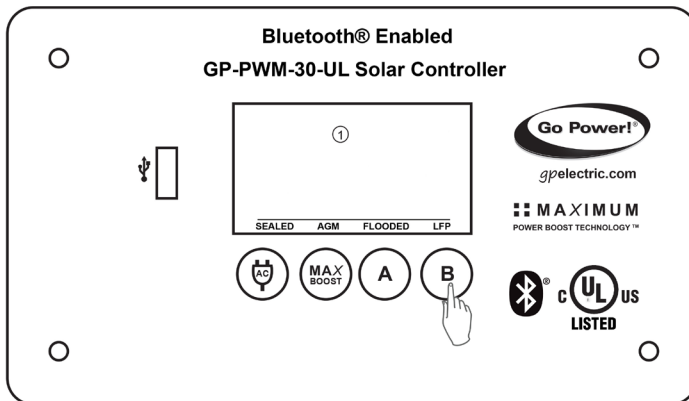

#### Setting Battery 1

To set the battery type for battery bank 1, hold the **B Button** for 3 seconds. When the display shows a blinking number 1, release the **B Button**.

Refer to the Battery Charge Profile Chart below for details on each profile.

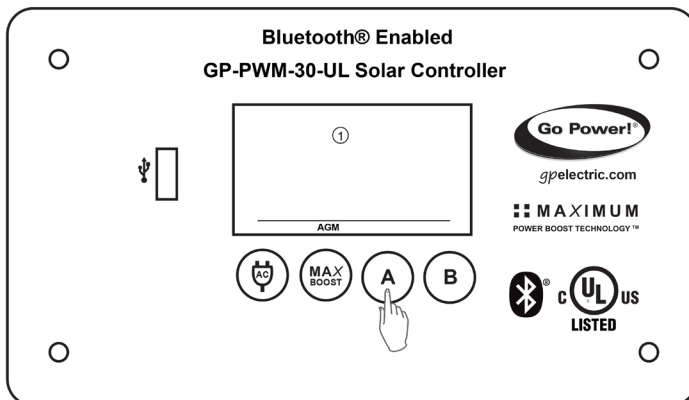

Next, select the charging profile of battery bank 1 by pressing the **B Button** to toggle through the profile options: Sealed/Gel, AGM, Flooded, or LFP.

To confirm the battery profile, press and hold the **A Button** for 3 seconds.

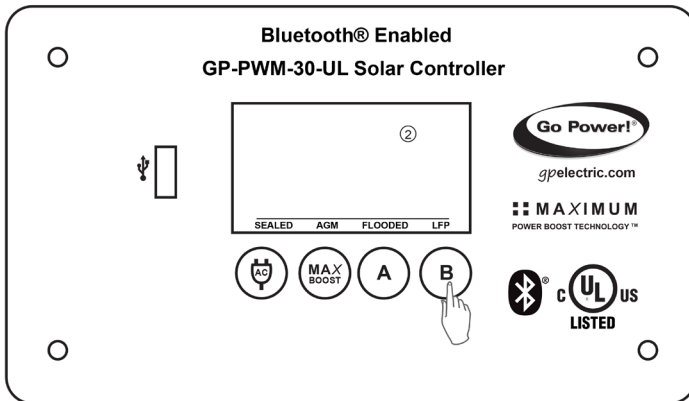

## Setting Battery 2

If you have a second battery bank connected, the controller will immediately prompt you to set the battery type for Battery 2 with a blinking number 2.

### Note

If there is not a second battery bank connected to the controller, or if the second battery bank is connected with reverse polarity, the controller will not prompt you to select battery type for Battery 2, and no status information will be displayed on the LCD screen.

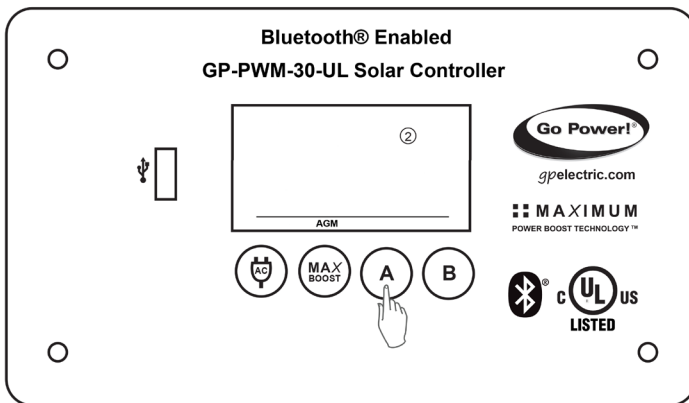

To select the charging profile of battery bank 2, press the **B Button** to toggle through the profile options: Sealed/Gel, AGM, Flooded, or LFP.

To confirm the battery profile, press and hold the **A Button for 3 seconds**.

**Non-volatile memory:** Any settings made on the GP-PWM-30-UL will be saved even when the power has been disconnected from the controller.

## 8.3 BATTERY CHARGING PROFILE CHART

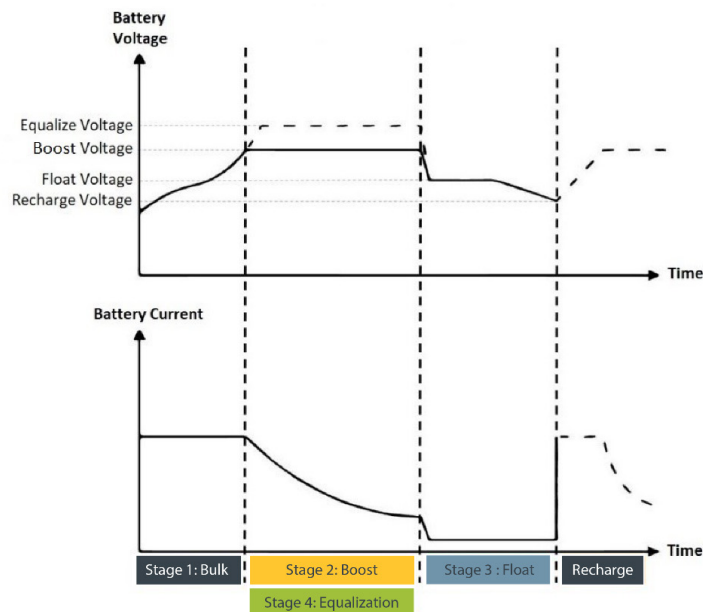



BATTERY TYPE	SEALED/GEL	AGM	FLOODED	LFP
Float Charge @ 25°C:	13.7V (+/- 0.1V)			N/A
Bulk/Absorption Charge @ 25°C: <i>Set to 30 minutes every morning. Applied for 2 hours if the battery voltage drops below 12.3 volts.</i>	14.1V (+/- 0.1V)	14.4V (+/- 0.1V)	14.4V (+/- 0.1V)	N/A
Equalization Charge @ 25°C: <i>Applied for 2 hours every 28 days and if the battery voltage drops below 12.1 volts.</i>	N/A	N/A	14.9V (+/-0.1V)	N/A
Absorption Charge voltage for LiFePO4: <i>Set to 30 minutes every morning</i>	N/A			14.4VDC
Float Charge voltage for LiFePO4:	N/A			14.0VDC
Temperature Compensation:	-24mV/K			None
If a charging cycle is unable to complete in a single day, it will continue the following day. The terms SEALED/GEL, AGM, FLOODED and LFP (LITHIUM) are generic battery designations. Choose the charging profile that works best with your battery manufacturer's recommendations.				

If PV power is insufficient or too many loads are drawing power from the battery, the controller will not be able to charge the battery to the target charging voltage.

**Auto Equalize:** The GP-PWM-30-SB has an automatic equalize feature that will charge and recondition your batteries at least once a month at a higher voltage to ensure that any excess sulfation is removed.

**Note** This mode should not be entered unless you are using a flooded battery.

### 8.4 MAXIMUM POWER BOOST TECHNOLOGY™

Maximum Power Boost Technology™ (MPBT) allows you to override the normal charging algorithm of the solar controller. MPBT is designed to be used before the end of the day, if you know you will require many loads through the night. This feature can also be used when you have just installed the solar controller, to put batteries on a boost charge up to 14.4 VDC (Flooded, AGM and LFP) (14.1 VDC for Sealed/Gel) right away.

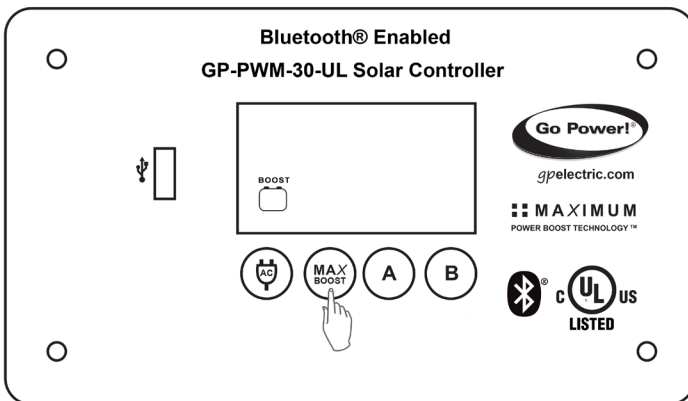

To activate, hold the **MAX BOOST Button for 3 seconds**. As long as there is full sunlight present, your battery voltage will be boosted (to 14.4 VDC for Flooded, AGM and LFP; and 14.1 VDC for SEALED/GEL) for 30 minutes regardless of the battery's state of charge.

**Icons Displayed:** BOOST; Battery Symbol

In older controllers, the BOOST text icon will remain on until the controller can maintain a Boost charge voltage for 30 cumulative minutes. In newer controllers, the BOOST text icon will only appear while the controller is maintaining a Boost charge voltage.

**IMPORTANT:** Do not use the Maximum Power Boost function more than twice a day as it could damage your lead acid batteries due to gassing. Sustained high voltages decrease lithium battery lifespan.

**Note**

If sunlight is insufficient or not available, completing Max Power Boost may take much longer than 30 minutes from the time of the button press. Max Power Boost and the BOOST icon cannot be turned off by pressing the Max BOOST button

## 8.5 VIEWING THE CONTROLLER DISPLAY INFORMATION

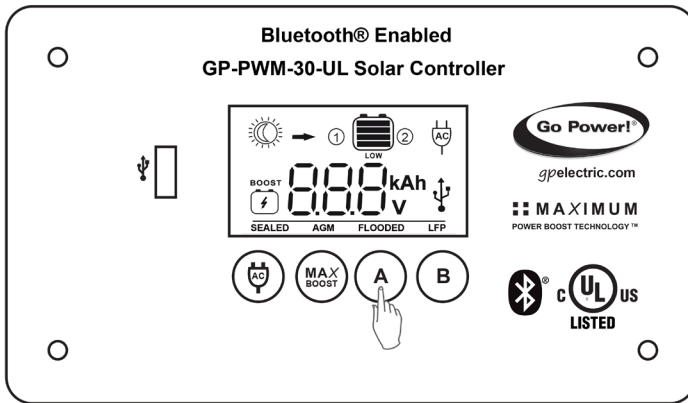

GP-PWM-30-UL has two modes to watch the display information, manual and auto scroll.

You can change between the two modes by holding down the **"A" Button for 5 seconds**. It will then cycle through Battery Voltage, Charge current, SOC and amp hours the controller has put to the battery. We are missing amp hours put to the battery. And explaining it is like an odometer on a car and counts down amp hours the controller has put to the battery from day one. It can be reset to zero on the app.

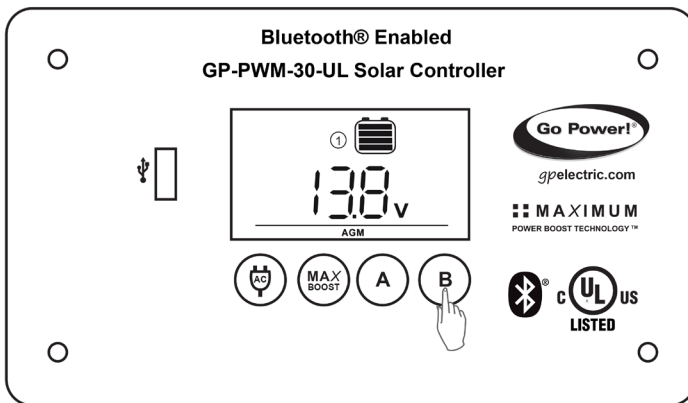

### Mode 1: Manually Scroll Through Display Information

#### Battery 1 Status Values

To toggle between Battery Voltage, Charging Current and Battery State of Charge (SOC) for Battery 1 and 2, press the **"B" Button**.

Push the **B Button** to show the voltage for Battery 1.

**Icons Displayed:** Battery SOC, Volt Symbol (V), Symbol 1

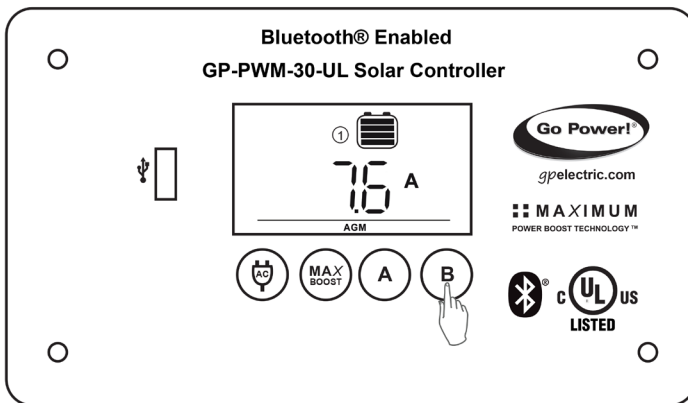

Push the **B Button** to show the PV charging current for battery 1. The GP-PWM-30-UL will begin to limit the current as Battery 1 reaches a full charge. The current that is not used for Battery 1, is used to charge Battery 2.

**Icons Displayed:** Arrow, Ampere Symbol (A), Battery SOC, Symbol 1

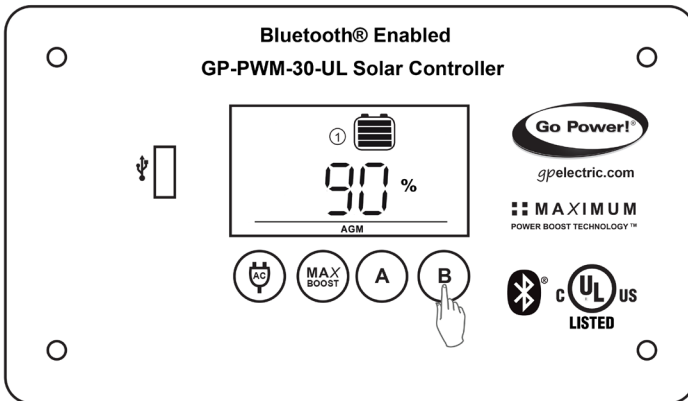

The battery state of charge is shown as a percentage.

**Icons Displayed:** Battery SOC, Percent Symbol (%), Symbol 1

A value of 100% will only be displayed after a Boost or Equalize charge completes.

**Battery 2 Status Values**

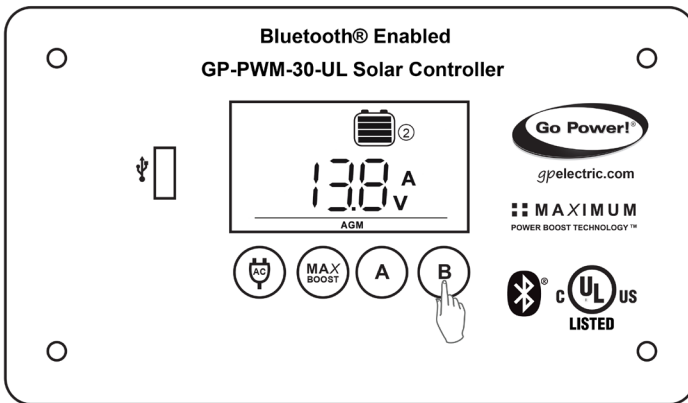

Push the **B Button** to show the battery 2 voltage.

**Icons Displayed:** Battery SOC, Volt Symbol (V),

**Symbol 2**

This will only be displayed if there are two battery banks connected and battery bank 2 is connected with correct polarity.

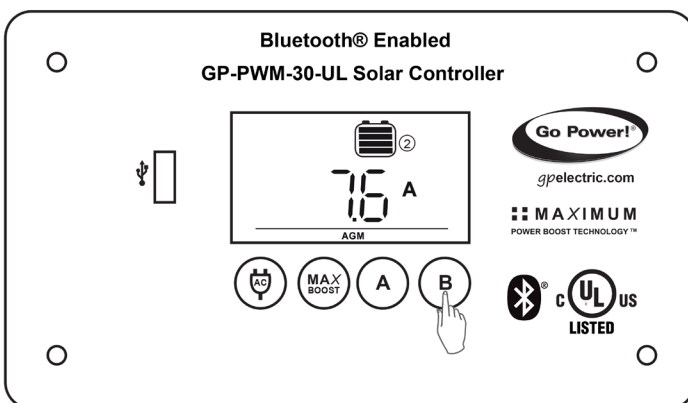

Push the **B Button** to show the PV charging current for battery 2. The GP-PWM-30-UL will begin to limit the current as the battery 2 reaches a full charge.

**Icons Displayed:** Arrow, Ampere Symbol, Battery SOC, Symbol 2

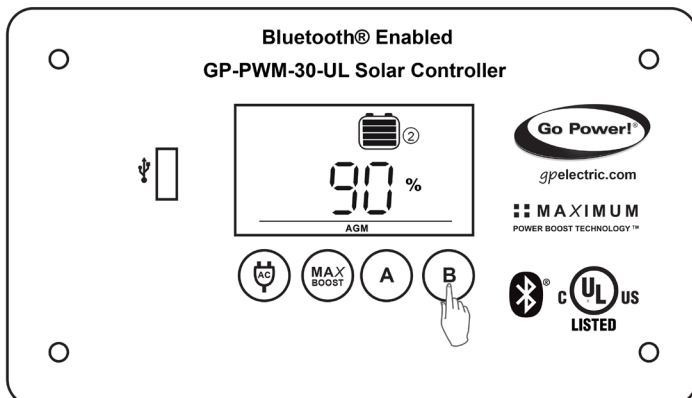

The battery state of charge is shown as a percentage.  
**Icons Displayed:** Battery SOC, Percent Symbol (%), Symbol 2

## Mode 2: Automatically Change Display Information

You can select the auto mode by holding down the “A” Button for 5 seconds.

The display shows the same information as in Mode 1 but changes the display automatically every 6 seconds between following information:

**Battery 1:** Voltage; PV Charging Current; Battery State of Charge (SOC)

**Battery 2:** Voltage; PV Charging Current; Battery State of Charge (SOC)

If Battery 2 is not connected, the Controller changes only the information for Battery 1.

## 8.6 RESETTING THE AMPERE HOURS CHARGED

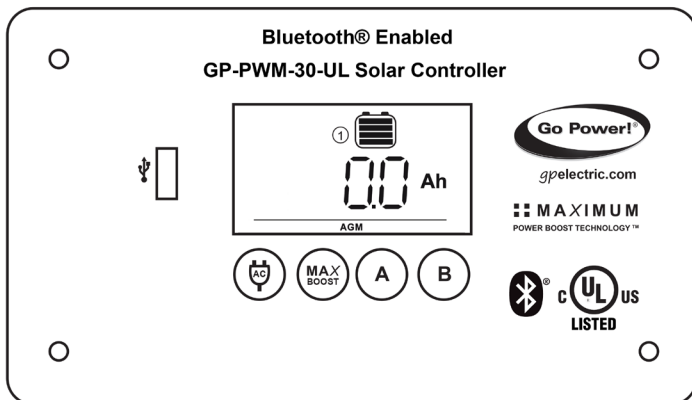

To reset the count of ampere hours charged, use the Go Power! Connect app (Bluetooth® enabled version only).

## 8.7 ERRORS

### OVER VOLTAGE

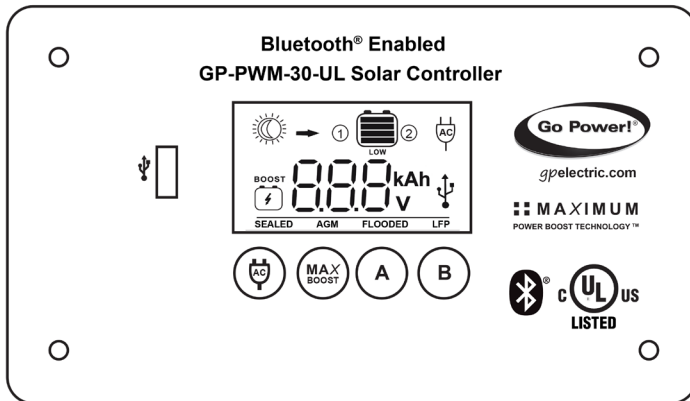

If the GP-PWM-30-UL experiences a battery over voltage (> 15.5 VDC) on battery bank 1, the controller will stop operating, and the display will begin to flash with all icons. The controller will resume operating when the voltage drops to a normal level < 15.5 VDC.

**Icons Displayed:** All symbols

**Note** The controller does not display over voltage on battery 2.

### LOW VOLTAGE

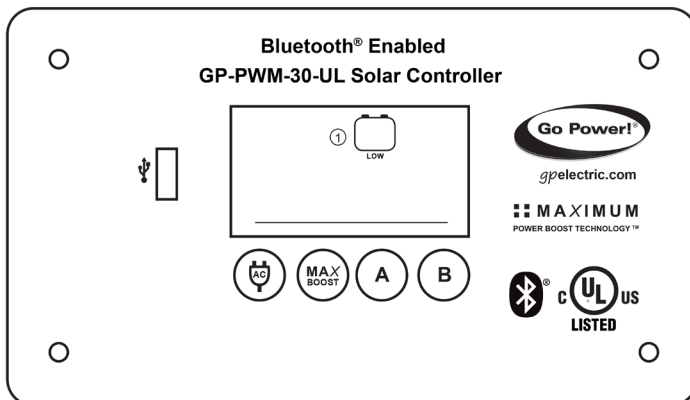

**Low battery 1:** If the SOC of battery bank 1 reaches 0%, the battery SOC symbol will show the text "LOW" beneath it. The controller will continue operating in this condition and will only stop operating if the voltage of Battery 1 drops below 9.0 VDC.

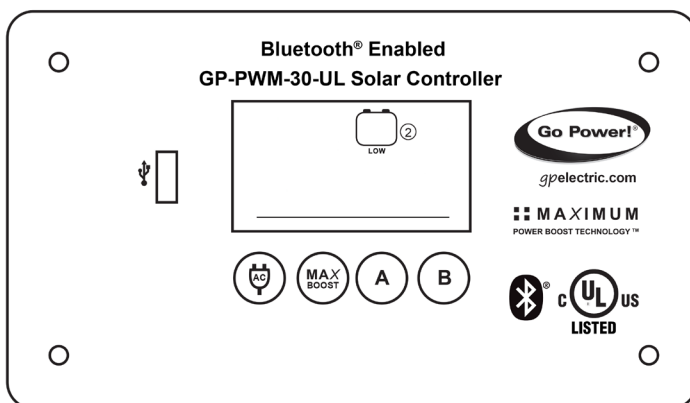

**Low battery 2:** If there are two battery banks connected and the SOC of battery bank 2 reaches 0%, the battery SOC symbol will show the text "LOW" beneath it. The controller will continue operating in this condition and will only stop operating if the voltage of Battery 1 drops below 9.0 VDC (this is because the GP-PWM-30-UL is powered by Battery 1).

**Icons Displayed:** Battery SOC Symbol, LOW, Symbol 1 or 2



## 9. DISPLAY SYMBOLS





### Battery 1 Reverse Polarity

If the GP-PWM-30-UL senses reverse polarity on battery 1, the controller will stop operating, beep continuously and display POL. The controller will resume operating when the error is cleared.

Icons Displayed: POL

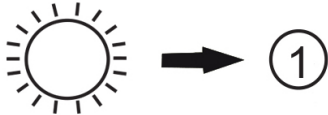
## 9. DISPLAY SYMBOLS

### BATTERY 1





SYMBOLS	INDICATOR FOR
	Day Time: PV Charge Current
	Night Time
	Battery Voltage
	Battery State of Charge
SEALED	Sealed/Gel
AGM	AGM/LFP
FLOODED LFP	Flooded Lithium Iron Phosphate

## BATTERY 2

SYMBOLS	INDICATOR FOR
	Day Time: PV Charge Current
	Night Time
	Battery Voltage
	Battery State of Charge
SEALED	Sealed/Gel
AGM	AGM/LFP
FLOODED	Flooded
LFP	Lithium Iron Phosphate

OTHER SYMBOLS	
	USB charger ON (when charger is OFF, no symbol will show)
	Inverter on (Can only be used when an inverter is hardwired. See Section 10. When inverter is off, no symbol shows)
	Flashing: Controller ready to pair Steady-on: Controller and mobile device connected via Bluetooth® communication
BOOST	Max Power Boost activated, Boost charge incomplete
LOW	Battery 1 / 2 voltage is lower than 11.0 VDC
Whole display will start to blink	Battery 1 voltage > 15.5 VDC
No Symbol	Battery 2 voltage > 15.5 VDC
POL	Battery 1 reverse polarity

**BATTERY STATE OF CHARGE**

SYMBOLS	BATTERY VOLTAGE
	Shows only after full Boost or Equalization Cycle
	>= 12.6V
	>= 11.8 -12.6V
	> 11.0 -11.8V
 <b>LOW</b>	<= 11.0V
100%  $SOC = \frac{\text{battery voltage} - 11.0V}{1.8V} * 90\%$	Shows only after full Boost or Equalization Cycle  < 12.8V and > 11.0V
0%	<= 11.0V

**10. INVERTER CONTROL ON/OFF**

The following Go Power!® inverters can be turned on/off through the GP-PWM-30-UL when a modular 6p4c RJ11 type connector is used (included with an optional Go Power!® inverter remote):

- GP-ISW700-12
- GP-ISW1000-12
- GP-ISW1500-TS
- GP-ISW1500-12
- GP-ISW2000-12

**Note** \*The GP-SW1500 Inverter is not compatible.



## INVERTER CONTROL ON/OFF

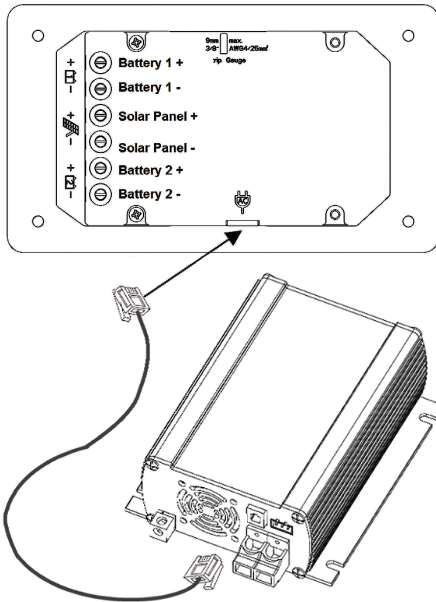

First, connect the inverter directly to the battery (follow the installation instructions included with the inverter).

Then, connect the modular cable (sold separately - Part # GP-COMM-CABLE) to the remote terminal of the inverter and to the remote terminal of the GP-PWM-30-UL (marked with an **AC Plug** symbol).

Please change the switch of the inverter to Position 2 (Remote controlled).

Now you can turn the connected inverter on or off by holding down the **AC Symbol** Button for 3 seconds.

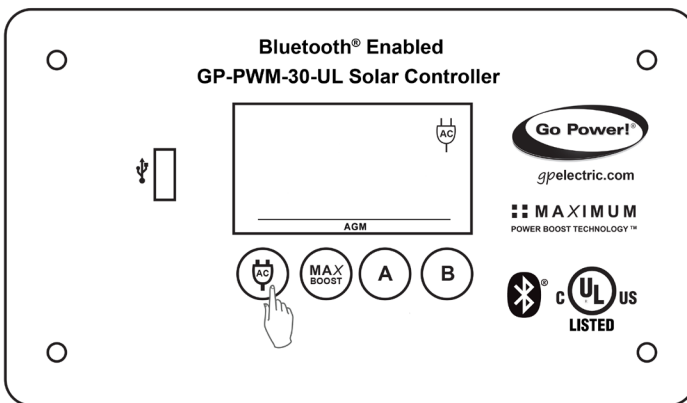

The inverter is enabled when the AC plug symbol appears on the display and is off when it disappears.

An automatic inverter low voltage disconnect (LVD) will be implemented in the LFP profile when the AC icon is active and the battery falls below 11.0V. The inverter will be reconnected once the battery has charged above 12.4V.

If the inverter is switched on by the AC button but LVD is recognized, then the **AC symbol** will flash. If the inverter is switched off by the AC button and/or by LVD, then the AC symbol will be off. If the inverter is switched on by the AC button and not switched off by LVD, then the AC symbol will be on.

## 11. USB CHARGING

The GP-PWM-30-UL offers a standard USB connector for delivering 5.0 VDC to small mobile appliances such as cell phones, tablets and small music players. This charging port can supply up to 800 mA of current.

Remove the rubber cover of the USB terminal to access the terminal.

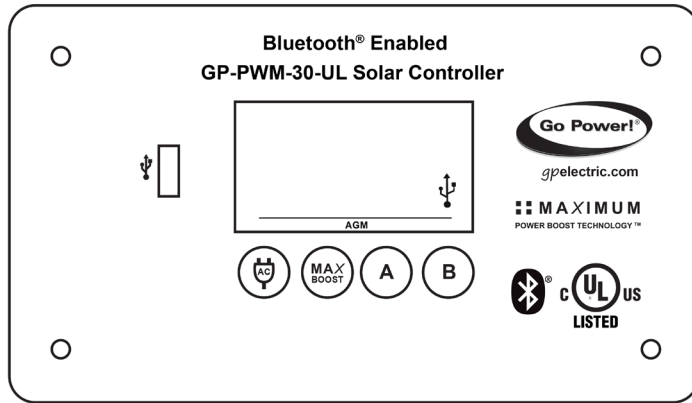

The USB charging port is active when the USB symbol appears on the display.

Battery 1, connected to the Battery 1 terminals, supplies the power for the USB charger.

The controller disables the USB charger automatically if the battery bank 1 voltage drops below 11.0 VDC, and the USB icon will turn off.

If there is enough current from the PV array available to charge Battery Bank 1 above the reconnect voltage, the USB terminal will be enabled again. For Sealed/Gel, AGM, and Flooded profiles, the reconnect voltage is 12.8V. For the LFP profile, the reconnect voltage is 12.4V.



**WARNING:** Do not connect the charging device anywhere else! USB-Negative contact is connected to battery negative.

## 12. BLUETOOTH® WIRELESS TECHNOLOGY

The GP-PWM-30-UL comes with Bluetooth® Low Energy wireless technology for live status monitoring and settings configuration on mobile devices. It works together with the Go Power! Connect App, available for both Android and iOS devices.



Download and install the Go Power! Connect app, which is available on the Google Play store for Android devices and the App Store for iOS devices.

### 12.1 PAIRING

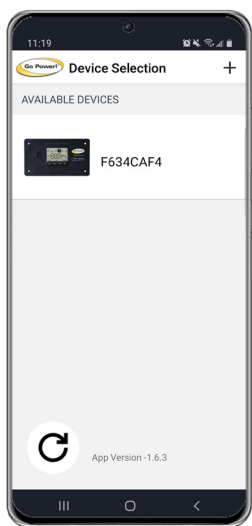

Open the app, and the Main page will prompt you to select devices.

Selecting the device should cause a connection to be automatically established. The Bluetooth® symbol on the charge controller's display will become solid and the monitor page of the Go Power! Connect App will be started. For step-by-step instructions, please visit our YouTube channel at [www.youtube.com/c/GoPowerSolar](http://www.youtube.com/c/GoPowerSolar) and head to the PWM-30-UL Solar Controller video playlist.

If you have an older PWM-30-UL model (pre-2022) and it does not connect, press and hold the **A and B buttons** of the charge controller simultaneously for 3 seconds until the Bluetooth® symbol on the charge controller's display starts flashing. Once this pairing process has been initiated on the charge controller, select the charge controller in the Device Selection main page of the Go Power! Connect app. For these older devices, selection from the app must be performed while the Bluetooth® symbol is still flashing on the charge controller's display. The flashing state will last for 60 seconds. If the charge controller is not selected on the Go Power! Connect app within this time, the pairing process is canceled, and the A and B buttons must be long pressed again.

**Note**

If you have a new PWM-30-UL controller that features the built-in Bluetooth® module the, Bluetooth® logo will NOT flash if the A and B buttons are held down, but will instead come on solid if the device establishes a Bluetooth® connection.

## 12.2 APP SETTINGS

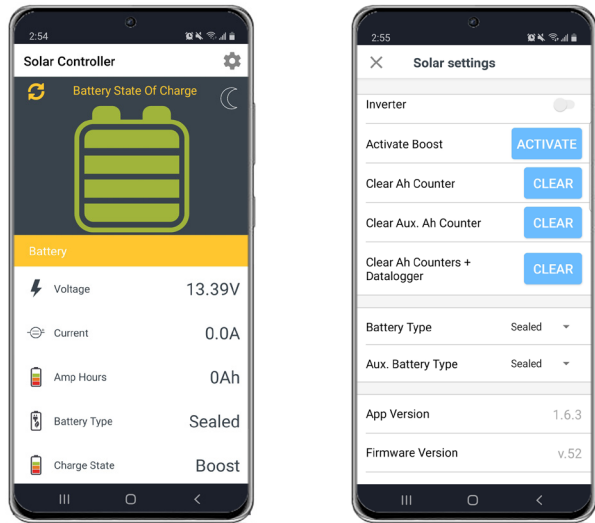

For a complete list of all functionality and instructions in the Go Power! Connect app, visit <https://gpelectric.com/support/>

## 12.3 GENERAL INFO

Returning to the Main page for Selecting devices will disconnect the charge controller. The Bluetooth® symbol on the charge controller's display will turn off to indicate the disconnection. The devices will still remain paired for future use.

The pairing process is only required once for mobile phones connecting for the first time. Paired mobile phones can then connect at any time without pressing buttons on the charge controller.

The charge controller can only be paired with one mobile device at a time.

A soft reset of the charge controller will erase the list of paired devices in the charge controller. The reset can be performed by pressing the 4 buttons of the charge controller simultaneously for 3 seconds.

## 13. FREQUENTLY ASKED QUESTIONS

Before a problem is suspected with the system, read this section. There are numerous events that may appear as problems but are in fact perfectly normal. Please visit <https://gpelectric.com/support/> for the most up-to-date FAQs and troubleshooting videos.

### It seems like my flooded batteries are losing water over time.

Flooded batteries may need to have distilled water added periodically to replace fluid loss during charging. Excessive water loss during a short period of time indicates the possibility of overcharging or aging batteries.

### When charging, my flooded batteries are emitting gas.

During charging, hydrogen gas is generated within the battery. The gas bubbles stir the battery acid, allowing it to receive a fuller state of charge. **Important: Ensure batteries are in a well-ventilated space.**

### My voltmeter shows a different reading than the GP-PWM-30-UL display.

The meter value on the GP-PWM-30-UL display is an approximate reading intended for indication purposes only. There is an approximate 0.1 VDC inherent error present that may be accentuated when compared with readings from another voltmeter.

## 14. TROUBLESHOOTING PROBLEMS



There may be a slight difference between the battery voltage displayed on the GP-PWM-30-UL display and the battery voltage measured at the battery terminals. When troubleshooting using a voltmeter, check both the battery voltage at the GP-PWM-30-UL controller terminals and battery voltage at the battery terminals. If a difference of more than 0.5 VDC is noted, this indicates a large voltage drop possibly caused by loose connections, long wire runs, small wire gauge, faulty wiring, a faulty voltmeter or all the above. Consult the Suggested Minimum Wire Gauge chart in Section 6 for wiring suggestions and check all connections.

### For advanced users:

The GP-PWM-30-UL makes voltage measurement adjustments based on resistance it detects at the battery terminals. In addition to resistance in the wires, batteries also have an internal resistance due to chemical properties. The controller cannot distinguish between these two sources of resistance. It will compensate up to 250mV in the displayed value.

### What causes a warning signal and when are the warnings triggered?

CONNECTION	WARNING	NOTES	LCD
Battery 1 reverse polarity	"POL" on LCD and constant audible alarm		
Battery 2 reverse polarity	Battery 2 status display doesn't show	Battery 1 must be connected with correct polarity for unit to be powered on	
PV reverse polarity	"POL" on LCD and constant audible alarm		
PV short circuit		Unit shows moon symbol when PV is connected and in bright sunlight	*must have bright sunlight on PV too

### Why does the voltage fluctuate so much when charging with the LFP setting?

Lithium batteries contain smaller battery cells. The voltages of these individual cells must be balanced during the charging process by the Battery Management System (BMS). Imbalances will cause fluctuations in the battery voltage measurement, but this will stabilize as the cells are charged and balanced.

Additionally, lithium batteries have higher resistance than lead acid batteries. This affects the charge controller's battery voltage measurements and its compensation for wire resistance.

Reduce wire inductance which may also cause voltage fluctuations. Keep battery wires close together, or gently twist positive and negative wires together.

### I don't see my charge controller in the Device Selection screen of the Go Power! Connect app.

The Device Selection screen will only display a charge controller that has already paired with the mobile device or a charge controller that is in the pairing process. The pairing process is initiated by pressing simultaneously the A and B buttons for 3 seconds. This is needed only when the mobile device is connecting with the charge controller for the first time.

### I cannot connect to the Go Power! Connect app.

The mobile device with the Go Power! Connect app has to be close enough to the charge controller. Distances of up to 20 meters in open space should work.

## 14. TROUBLESHOOTING PROBLEMS

### How to Read this Section

Troubleshooting Problems is split into three sub-sections, grouped by symptoms involving key components. Components considered irrelevant in a diagnosis are denoted 'Not Applicable' (N/A). A multimeter or voltmeter may be required for some procedures listed.

It is imperative all electrical precautions stated in the Warning Section and outlined in the Installation Section are followed. Even if it appears the system is not functioning, it should be treated as a fully functioning system generating live power.



## 14.1 PROBLEMS WITH DISPLAY

### Display Reading: Blank

Time of Day: Daytime/Nighttime

#### Possible Causes:

Battery or fuse connection and/or solar array connection (Daytime only) or battery or fuse connection (Nighttime only).

#### How to tell:

1. Check the voltage at the controller battery terminals with a voltmeter and compare with a voltage reading at the battery terminals.
2. If there is no voltage reading at the controller battery terminals, the problem is in the wiring between the battery and the controller. If the battery voltage is lower than 6 volts the controller will not function.
3. For the solar array, repeat steps 1 and 2 substituting all battery terminals with solar array terminals.

#### Remedy:

Check all connections from the controller to the battery including checking for correct wire polarity. Check that all connections are clean, tight, and secure. Ensure the battery voltage is above 6 volts.

### Display Reading: Nighttime

Time of Day: Daytime

#### Possible Causes:

Panel is covered by something; PV panel is too dirty to supply a high enough voltage to charge the battery; PV panel is not connected.

#### Remedy:

Check the panel and to ensure it is not obscured. Clean the panel if it is dirty. Check that PV cables are connected to the controller.

## 14.2 PROBLEMS WITH VOLTAGE

### Voltage Reading: Inaccurate

Time of Day: Daytime/Nighttime

#### Possible Causes:

Excessive voltage drop from batteries to controller due to loose connections, small wire gauge or both.

#### How to tell:

1. Check the voltage at the controller battery terminals with a voltmeter and compare with the voltage reading at the battery terminals.
2. If there is a voltage discrepancy of more than 0.5 V, there is an excessive voltage drop.

#### Remedy:

Check all connections from the controller to the battery including checking for correct wire polarity. Check that all connections are clean, tight, and secure. Shorten the distance from the controller to battery or obtain larger gauge wire. It is also possible to double up the existing gauge wire (i.e. two wire runs) to simulate a larger gauge wire.

## 14.3 PROBLEMS WITH CURRENT

### Current Reading: 0 A

Time of Day: Daytime, clear sunny skies

#### Possible Cause:

Current is being limited below 1 Amp as per normal operation or poor connection between solar array and controller.



## How to tell:

1. The State of Charge (SOC) screen is close to 100% and the Sun and Battery icon are present with an arrow between.
2. With the solar array in sunlight, check the voltage at the controller solar array terminals with a voltmeter.
3. If there is no reading at the controller solar array terminals, the problem is somewhere in the wiring from the solar array to the controller.

## Remedy:

Check all connections from the controller to the array including checking for correct wire polarity. Check that all connections are clean, tight, and secure. Continue with the solutions below for additional help on low current readings.

## Current Reading: Less than expected

Time of Day: Daytime, clear sunny skies

## Possible Causes:

1. Current is being limited below 1 Amp as per normal operation.
2. Incorrect series/parallel configuration and/or wiring connections and/or wire gauge.
3. Dirty or shaded module or lack of sun.
4. Blown diode in solar module when two or more modules are connected in parallel.
5. The battery is full

## How to tell:

1. Battery State of Charge screen is close to 100% and the Sun and Battery icon are present with an arrow in between.
2. Check that the modules and batteries are configured correctly. Check all wiring connections.
3. Modules look dirty, overhead object is shading modules or it is an overcast day in which a shadow cannot be cast.

## Note

Avoid any shading no matter how small. An object as small as a broomstick held across the solar module may cause the power output to be reduced. Overcast days may also cut the power output of the module

4. Disconnect one or both array wires from the controller. Take a voltage reading between the positive and negative array wire. A single 12 volt module should have an open circuit voltage between 17 and 22 volts. If you have more than one solar module, you will need to conduct this test between the positive and negative terminals of each module junction box with either the positive or the negative wires disconnected from the terminal.

## Remedy:

1. Reconnect in correct configuration. Tighten all connections. Check wire gauge and length of wire run. Refer to Suggested Minimum Wire Gauge in **Section 5**.
2. Clean modules, clear obstruction or wait for conditions to clear.
3. If the open circuit voltage of a non-connected 12 volt module is lower than the manufacturer's specifications, the module may be faulty. Check for blown diodes in the solar module junction box, which may be shorting the power output of module.



## 15. WARRANTY

---

Go Power! warrants the GP-PWM-30-UL for a period of five (5) years from the date of shipment from its factory. This warranty is valid against defects in materials and workmanship for the five(5) year warranty period. It is not valid against defects resulting from, but not limited to:

- Misuse and/or abuse, neglect or accident
- Exceeding the unit's design limits
- Improper installation, including, but not limited to, improper environmental protection and improper hook-up
- Acts of God, including lightning, floods, earthquakes, fire, and high winds
- Damage in handling, including damage encountered during shipment

This warranty shall be considered void if the warranted product is in any way opened or altered. The warranty will be void if any eyelet, rivets, or other fasteners used to seal the unit are removed or altered, or if the unit's serial number is in any way removed, altered, replaced, defaced, or rendered illegible.

### 12.1 REPAIR AND RETURN INFORMATION

Visit [www.gpelectric.com](http://www.gpelectric.com) to read the "frequently asked questions" section of our website to troubleshoot the problem. If trouble persists:

1. Fill out our online Contact Us form or Live Chat with us
2. Email [techsupport@gpelectric.com](mailto:techsupport@gpelectric.com)
3. Return defective product to place of purchase

# 16. INSTALLATION TEMPLATE

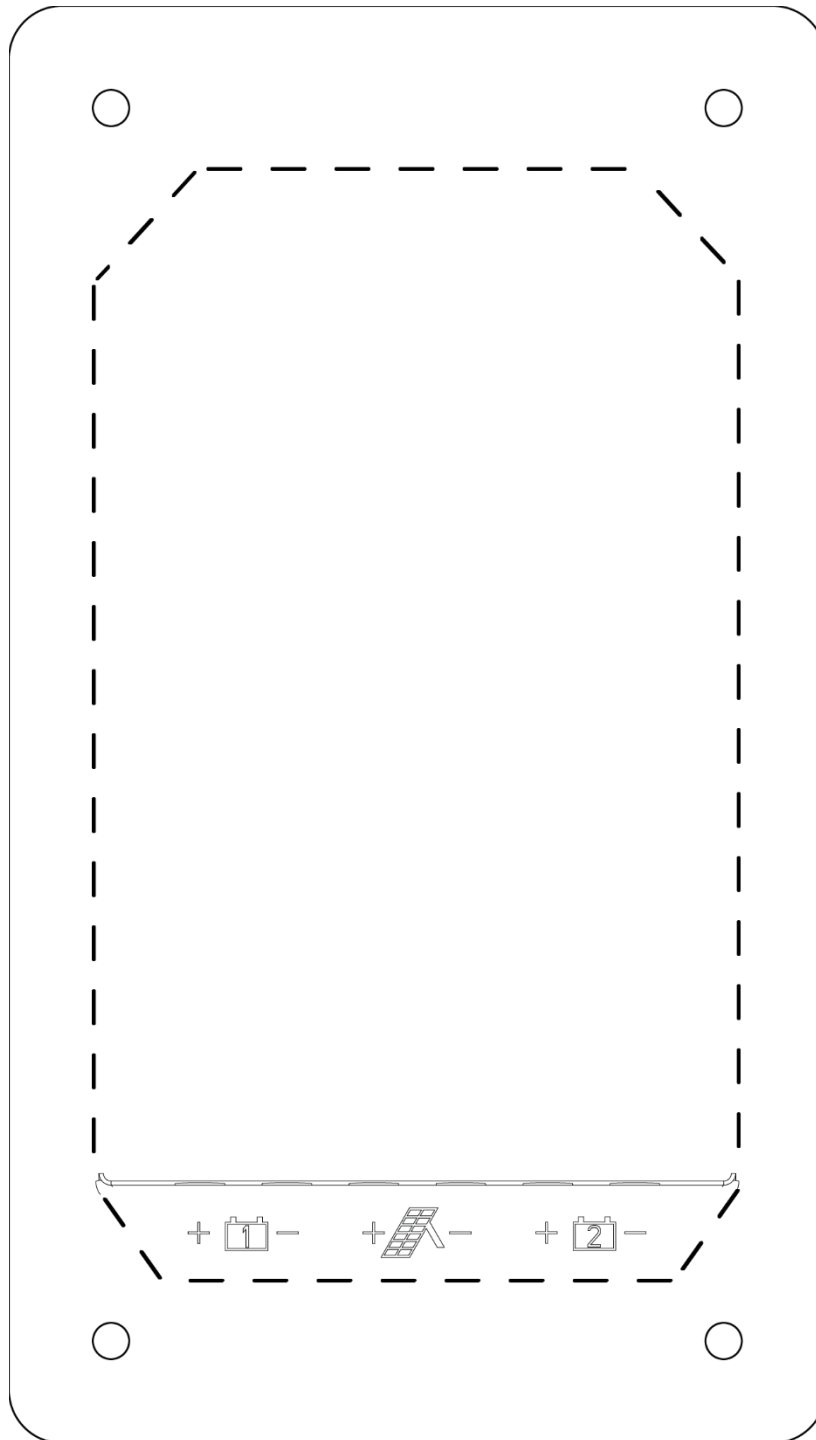

© 2022 Go Power!

Worldwide Technical Support and Product Information [gpelectric.com](http://gpelectric.com)

Go Power! | Dometic

201-710 Redbrick Street Victoria, BC, V8T 5J3

Tel: 1.866.247.6527

Manual\_GP-PWM-30-UL

